

esto es cantarranas:

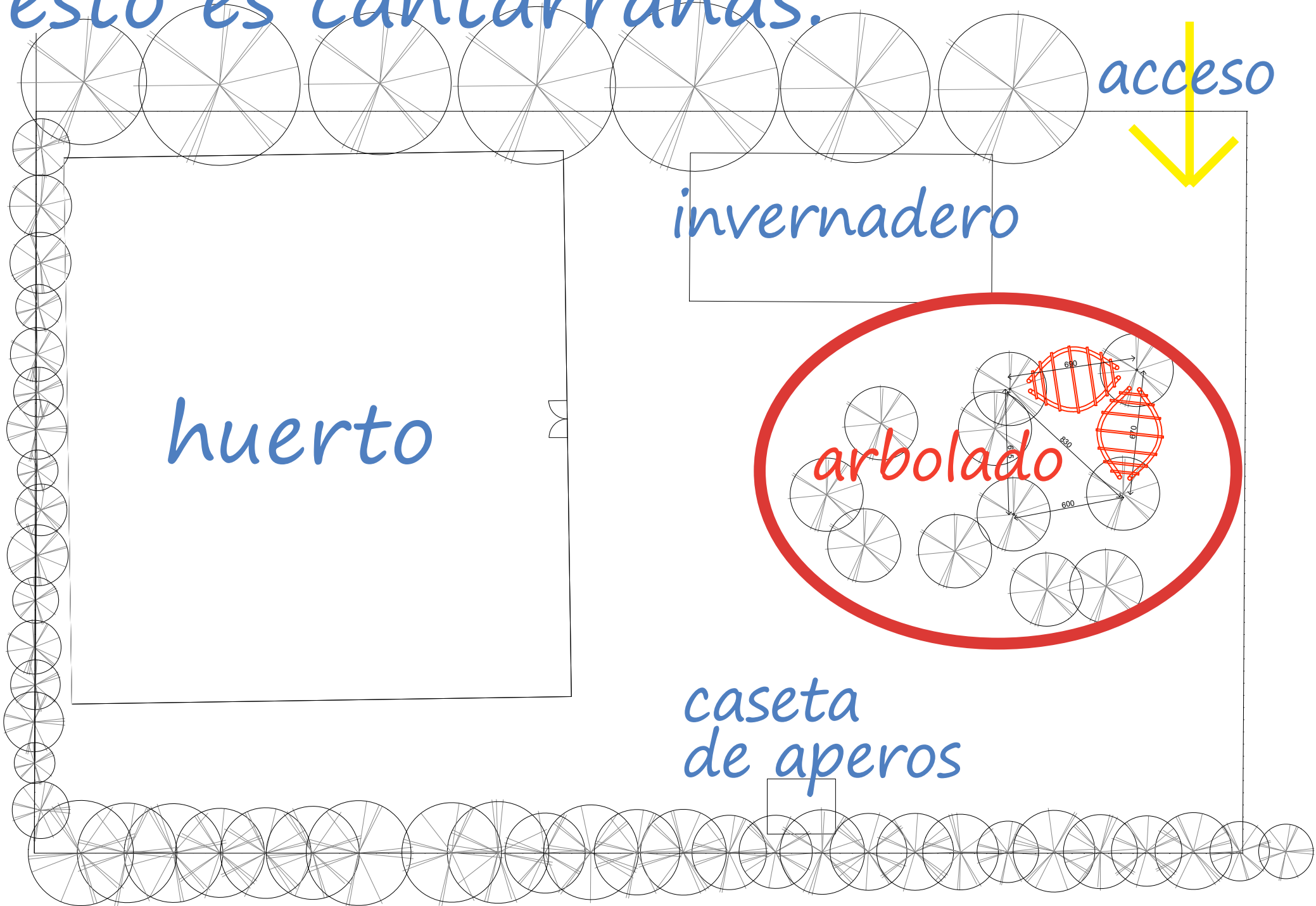

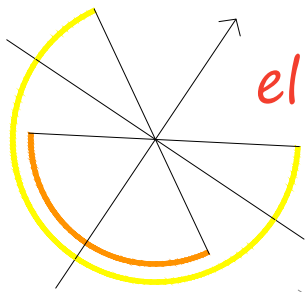

el norte va por ahí!

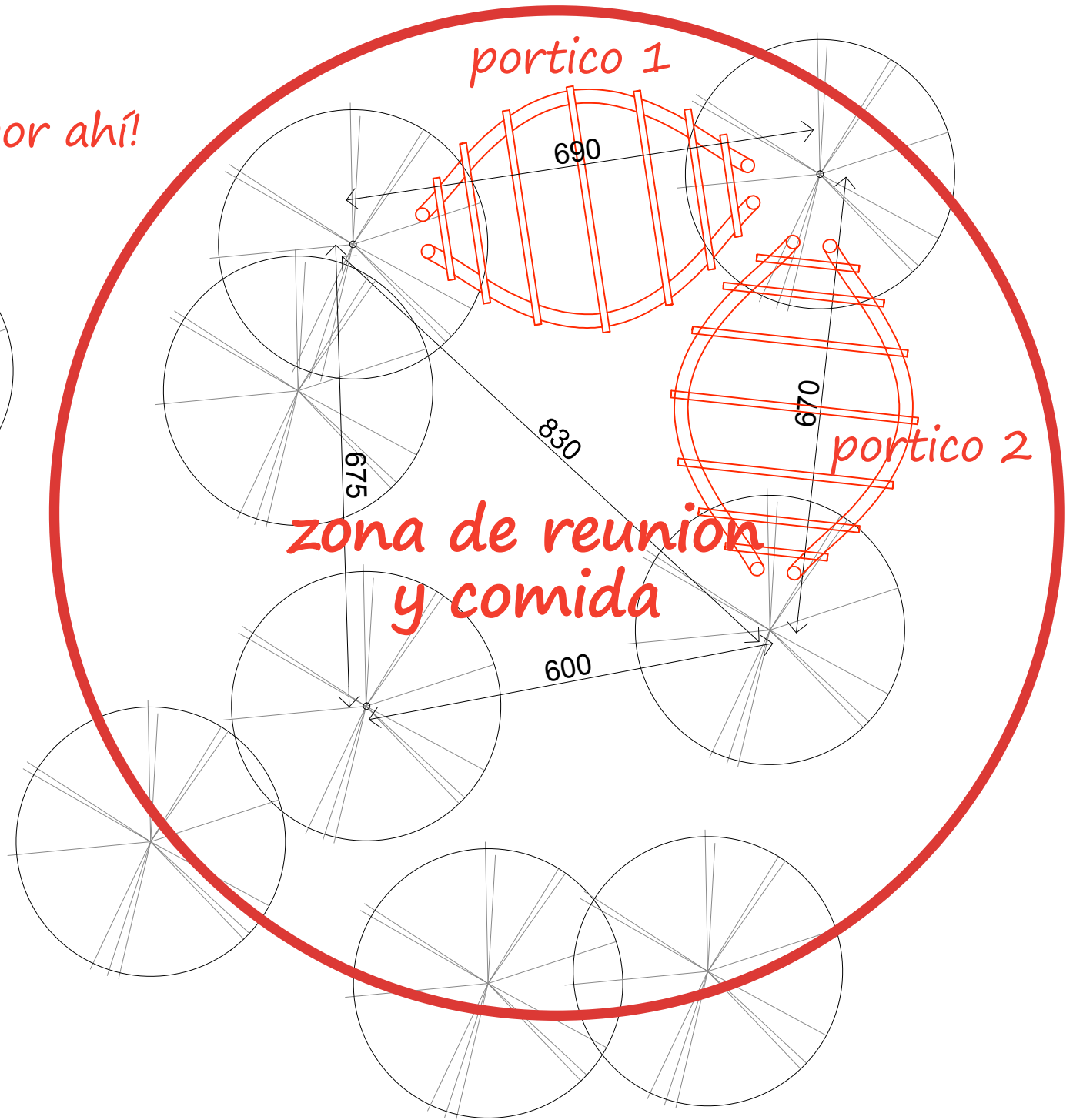
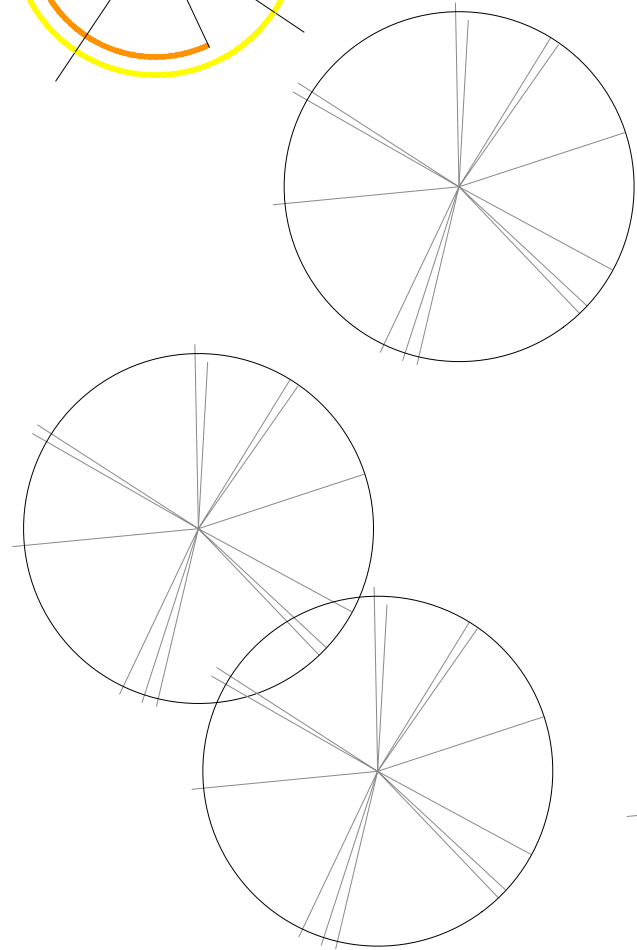

portico 1

690

675

830

zona de reunion
y comida

600

670

portico 2

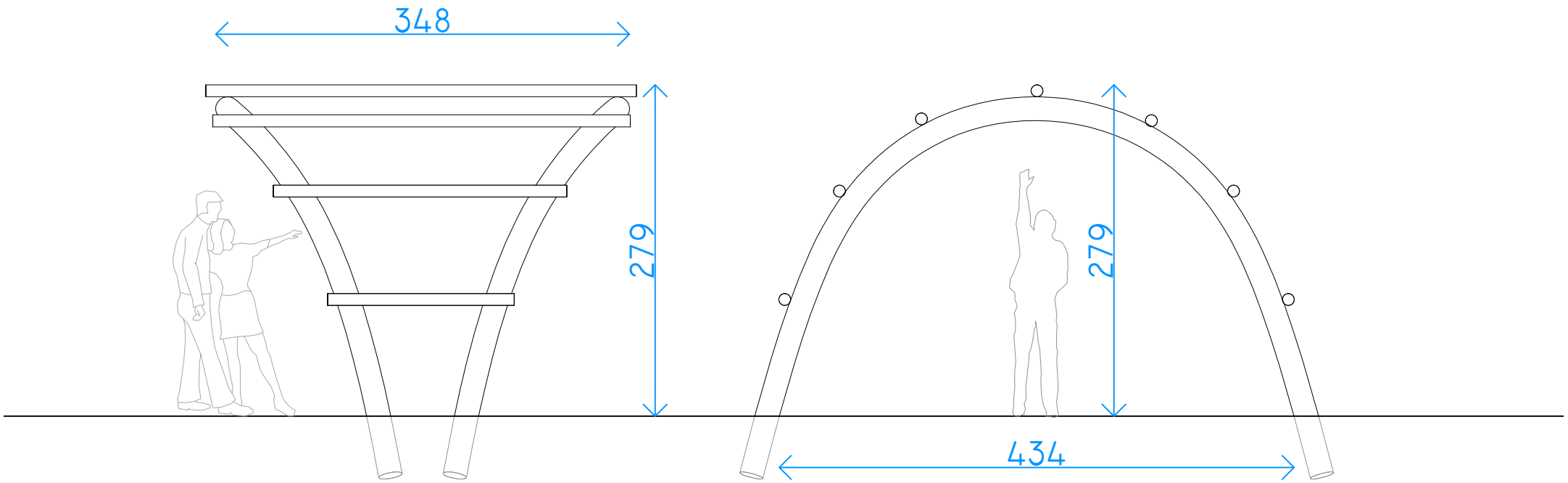

Así que serían dos de esto!

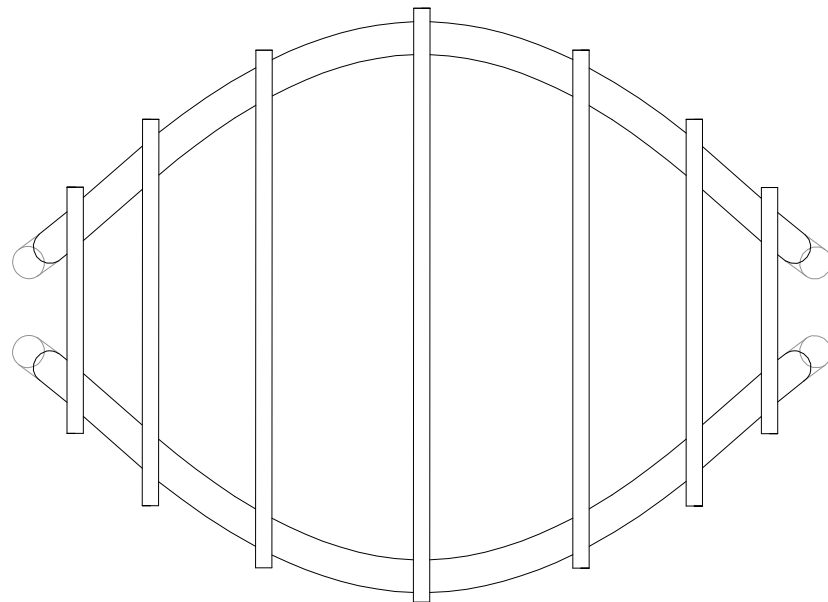

sombra a los equinocios

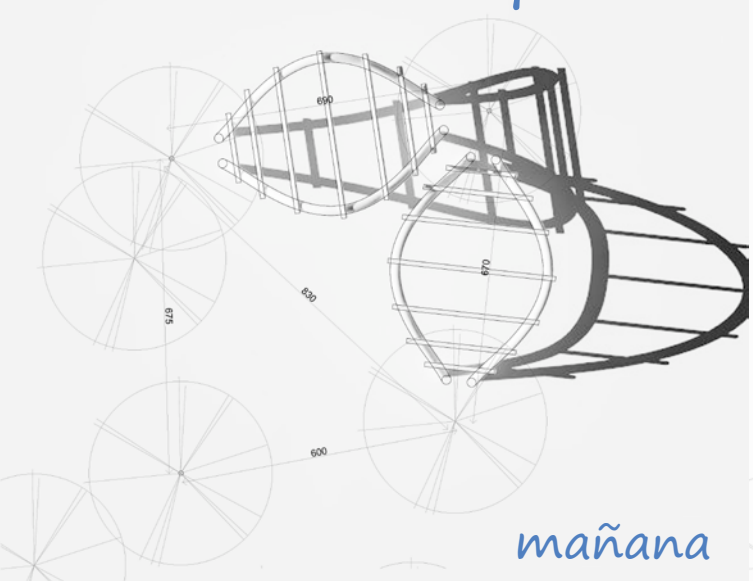

mañana

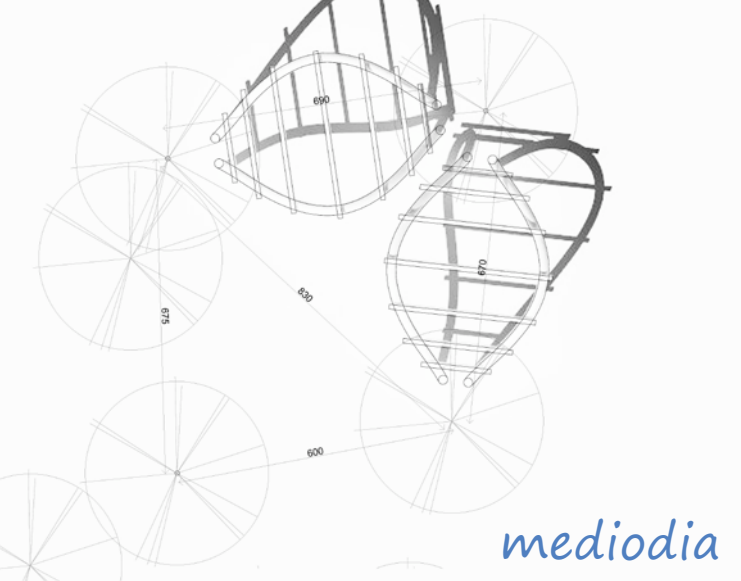

mediodia

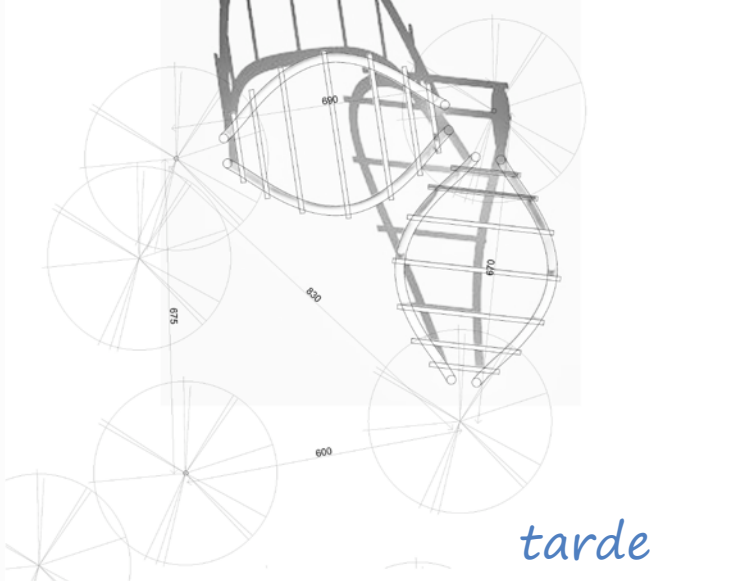

tarde

sombra al solsticio de verano

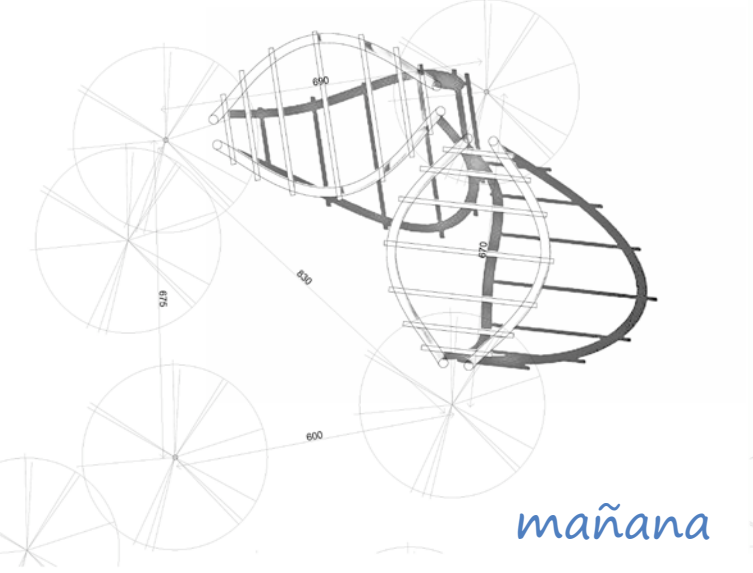

mañana

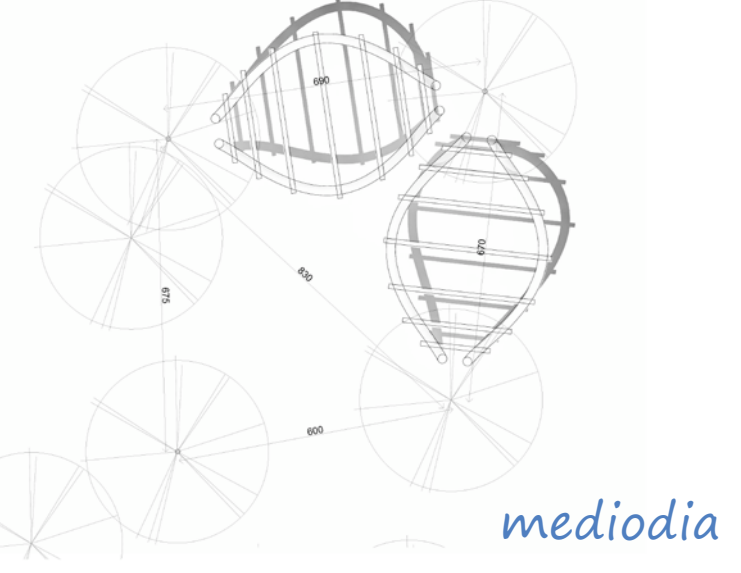

mediodia

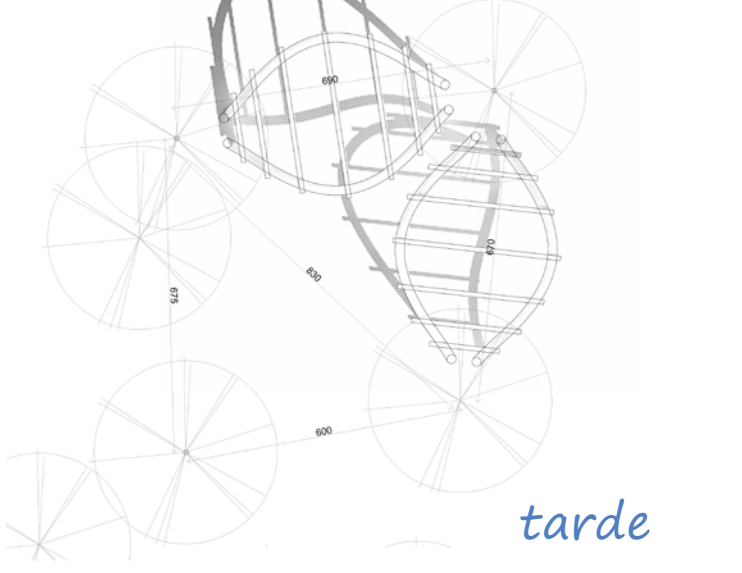

tarde

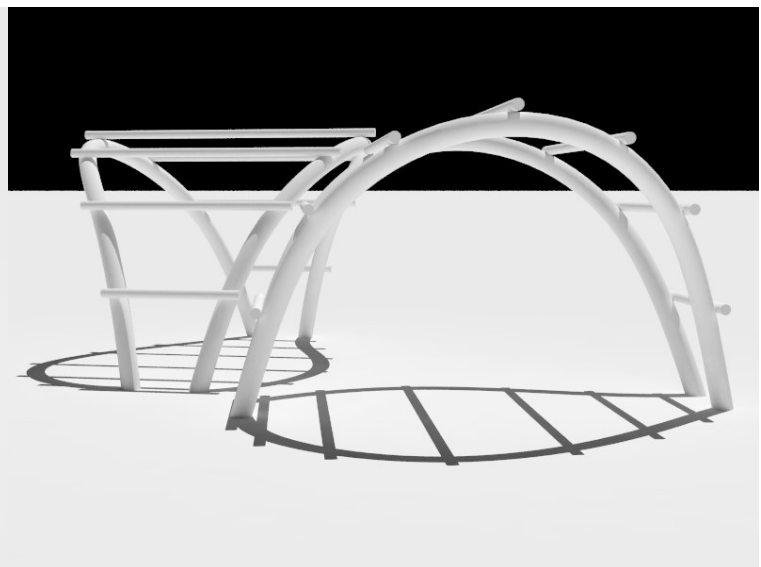
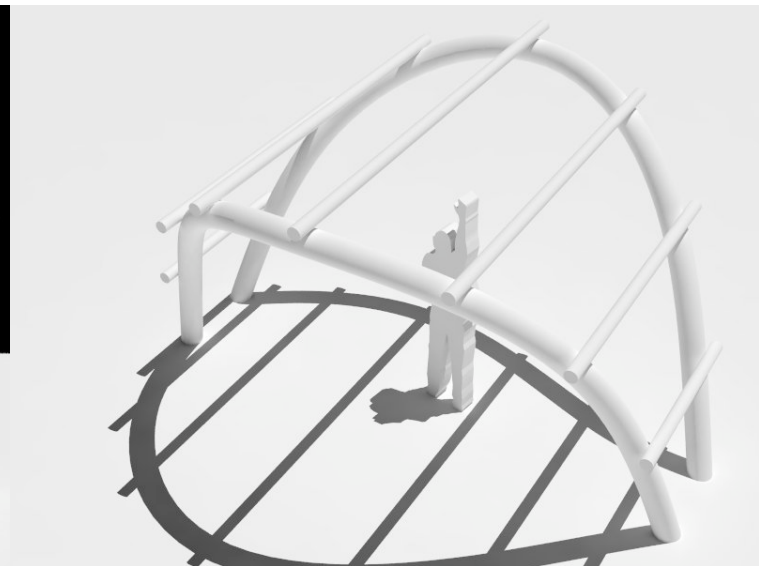
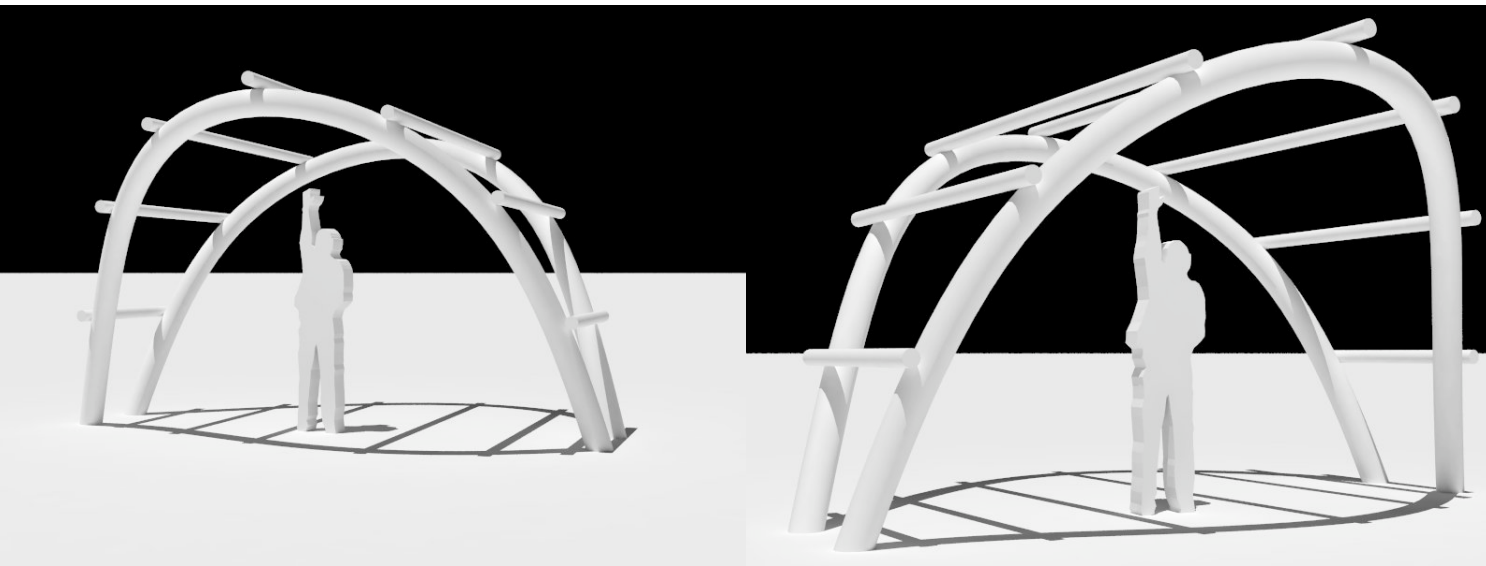

imaginarlos con los arboles alrededor...